

YT-1000R BRACKET INSTALLATION MANUAL

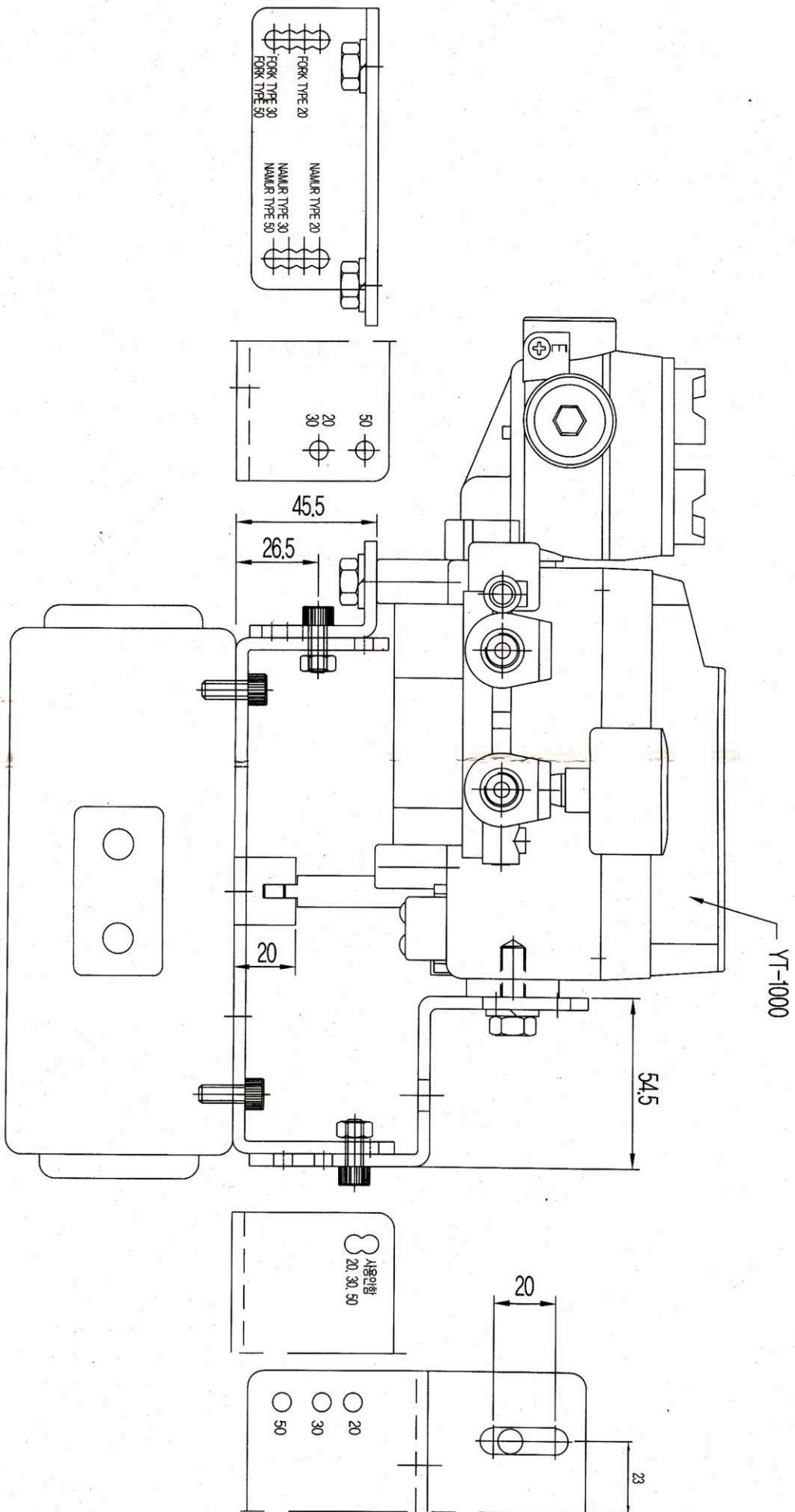

The electro-pneumatic positioner YT-1000R is used for rotary operation of pneumatic rotary valve actuators by means of electrical controller or control systems with an analog output signal of 4 to 20 mA or split ranges.

1. STRUCTURES

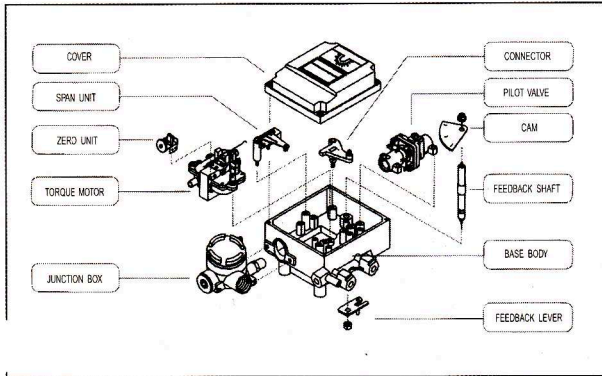

2. INSTALLATION

2-1. Example of attaching to actuator

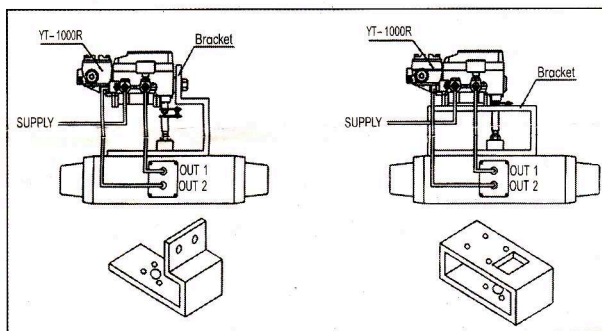

ex 1) case of using the positioner side screw

ex 2) case of using the positioner back screw

2-2. Connection with feedback shaft Attach to the position at which the positioner feedback shaft and the rotary actuator main shaft are almost concentric (range in which the spring pin of feedback shaft edge enters the hole of fork lever assembly shaft edge).

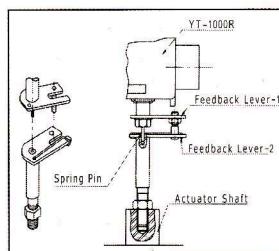

2-3. Cam attaching procedure

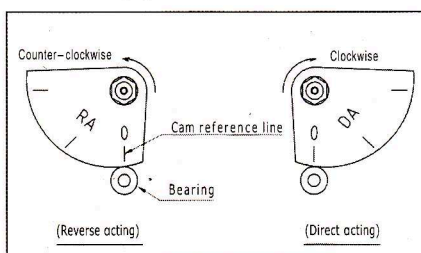

1 Use the DA face of cam to turn the actuator main shaft clockwise (viewed from the positioner front cover side) at the time of input feedback shaft.

Use the RA face to turn it counterclockwise. (reverse action).

Correctly attach the cam to the flange part of feedback shaft.

2 Attach the cam in the procedure of loosening the hexagonal nut with flange first, setting the using actuator to the starting position and then setting the cam reference line and the bearing contact point of span adjusting arm unit to the matching position.

3 Do not apply the supply pressure when attaching the cam as otherwise it is very dangerous.

4 When the positioner is shipped out of our plant, the cam is tentatively tightened to the shaft. Be sure to firmly lock the cam to the lock nut.

(tightening torque 2.0 ~ 2.5 Nm (20 ~ 25 kgfcm).

2-4. Attaching procedure of opening degree indication plate

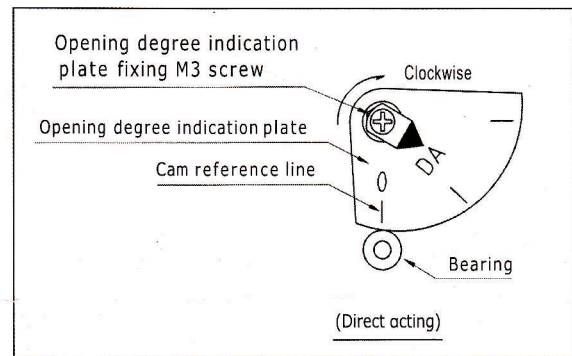

1 Lock the cam and then adjust the zero point and span. Then fix the opening degree indication plate to the shaft using the M3 screw provided.

At the time, set the opening degree indication plate to the state of attaching reference line.

3. AIR PIPING CONNECTION

Direct Action	Reverse Action
<p>As the input current increases.</p> <p>Actuator Stem rotates in clockwise.</p>	<p>As the input current increases.</p> <p>Actuator Stem rotates in counterclockwise.</p>
<p>As the input current increases.</p> <p>Actuator Stem rotates in clockwise.</p>	<p>As the input current increases.</p> <p>Actuator Stem rotates in counterclockwise.</p>

1 Fully purge the pipe to remove foreign matter.

2 Use a clean supply air fully removed humidity and dust.

3 Use YT-200 filter regulator to keep supply air pressure constantly.

4 When using the double acting type as the single acting type, blind either OUT1 or OUT2 and also remove the pressure gauge to close its connection.

4. ELECTRICAL WIRING

- ① Connect the (+) and (-) output terminals from the regulator with the (+) and (-) input terminals, respectively, of the positioner Junction box.
- ② For Explosion Proof, both pressure tight conduit thread connection type and pressure tight packing type are available.
 - ① Use Cable Gland in pressure tight packing type. (Cable O.D. = 9.0~ 11).
 - ② Use PF 1/2 standard for conduit thread connection type.
- ③ Close Junction box cover and lock Key lock screw. There is a Spare Bolt in terminal board.

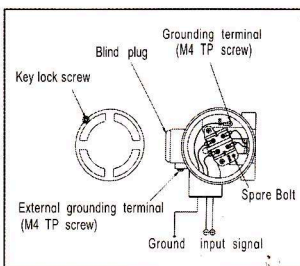

Exdm IIB T6

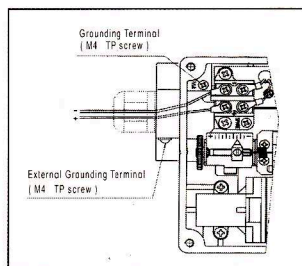

Exia IIB T6

5. ADJUSTMENT

5-1 Zero Adjustment

- ① Set an signal to the Stroke starting signal(4mA) then turn the Zero Adjuster clockwise or counterclockwise
- ② In case of Spring Actuator, check if it is set to standard pressure in Zero Point. If not, repeat Zero adjustment.

5-2 Span Adjustment

- ① Adjust Range Adjustment so that an Actuator stops at 0% position of the Stroke by the 0% applied input signal and 100% position for 100% input signal respectively.
- ② Check Zero Point and repeat Zero Span Adjustment. 1/2 Split Range can be used by Zero and Span Adjustment.
- ③ After Setting, tighten up Lock Screw of Span adjustment.

<Zero Adjustment>

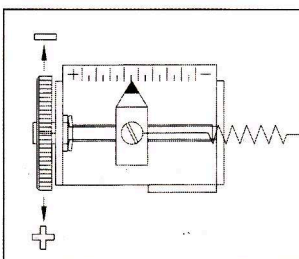

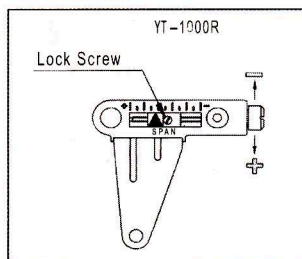

5-3 Auto/Manual Switch

- ① This is a Switch for changing Auto and Manual. Shipped products is set for Auto. To use Manual operation, turns A/M Switch counterclockwise.
- ② In manual operation, the pressure of YT-200 regulator connects to Actuator.
- ③ After using, return switch to "A". Not available for Single Acting-OUT2 and Double Acting.

5-4 Seat Adjuster

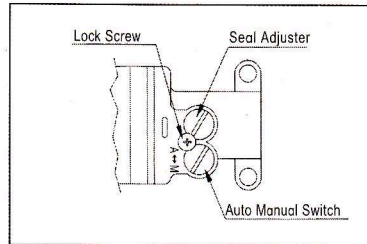

- ① No need to adjust at the field because Seat Adjuster is to be adjusted before shipment for balanced pressure point of output pressure.
- ② Seat Adjuster is always used for Double-acting. If need to change balanced pressure point of output pressure, use Seat Adjuster.
- ③ If the sensitivity is poor because of the actuator type of load condition, turn the seat adjuster screw clockwise. If hunting occurs, turn the seat adjuster screw counterclockwise. (The amount of turning varies by actuators. Do not loosen the stopper screw at this time since it is set to avoid coming off the seat adjuster.)
- ④ If hunting occurs due to an actuator of small capacity, refer to description in chapter 6. OPTION.

6. OPTION

6-1 Pilot valve with output orifice

- ① Hunting may occur when the positioner is attached to a small capacity actuator. In such case, use a pilot valve having a output orifice for OUT1 and OUT2. The output orifice is removable.
- ② Output orifice types

Volume of actuator	Output orifice diameter	Ordering NO.
below 90cm ³	∅ 0.7	①
90 ~ 180cm ³	∅ 1.0	②
over 180cm ³	None	③
- ③ After pulling out the O-ring from OUT1 and OUT2 port; push proper orifice and then mount the O-ring to OUT1 and OUT2 again. When mounting the output orifice, pay attention not to let dust and others enter the port hole.
- ④ If the hunting dose not stop even after mounting the output orifice, please contact us.

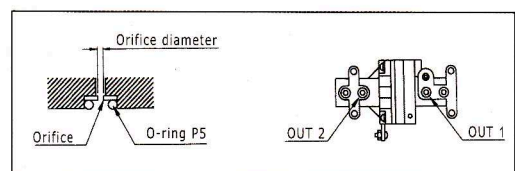

6-2 Feedback lever Type

